

General Specifications

Models ALR111, ALR121 Serial Communication Modules



GS 32Q06K50-31E

■ GENERAL

This document describes about Models ALR111 and ALR121 Serial Communication Modules used with a safety control station (SCS) for performing Modbus communication.

By using the SCS's Modbus slave communication function, the data in SCS can be set or referred to by the Modbus master which is as separate system from SCS via a serial communication module. Furthermore, the subsystem data such as from sequencers can be set or referred to via a serial communication module using SCS's subsystem communication function.

These serial communication modules can be mounted on SSC60□, SSC50□, SSC57□, and SSC10□ safety control units and SNB10D safety node unit that are connected with safety control units by ESB bus.

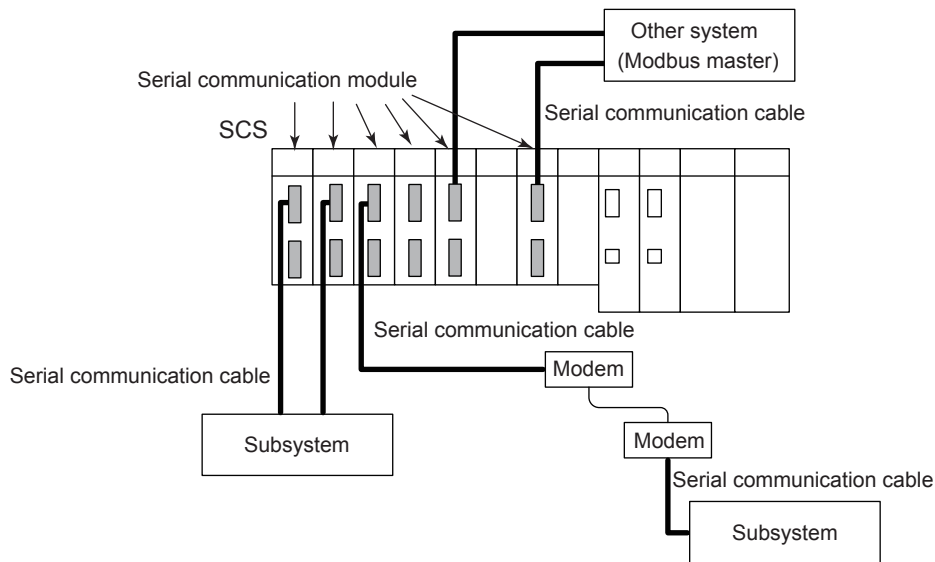

F01E.ai

Figure A sample configuration of the serial communication modules

■ HARDWARE SPECIFICATIONS

Hardware specifications of ALR111 and ALR121 serial communication modules are as shown below. These modules are interference-free modules that have no interference with the safety loop.

Table Serial Communication Module Hardware Specifications

Item	Specifications	
	ALR111	ALR121
Interface	RS-232C	RS-422/RS-485 (4-wire system)
Connection method	Point-to-point	Point-to-point (RS-422) Multipoint (RS-485)
Communication function	Half-duplex	
Synchronization method	Start-stop synchronization	
Transmission speed	1200/2400/4800/9600/19200/38400 bps	
Transmission code	binary	
Character length	8 bits (Fixed to 8 bit on the Modbus slave communication function and the subsystem communication function)	
Stop bit length	1/2 bits (Fixed to 1 bit on the subsystem communication function)	
Parity check	None/even/odd	
Lag time after data transmission	1 ms	
Transmission distance	Maximum 15 m	Maximum 1200 m (total extended length)
Installation method	Mounted on SSC60□, SSC50□, SSC57□, SSC10□, or SNB10D (*1)	
I/O wiring	AKB131, AKB132, AKB135, AKB136 cables, etc.	Cable with 3-pair shield, AKB161, or AKB162
Wiring connection	D-sub-9-pin (female × 2 ports)	Clamped with terminal block's M4 screws (5 poles × 2 ports)
Communication function (*2)	Modbus slave communication function, subsystem communication function	
Current consumption	0.5 A	0.5 A
Weight	Approx. 0.3 kg	Approx. 0.34 kg

*1: SNB10D connects with SSC60□, SSC50□, SSC57□, or SSC10□ by ESB bus.

*2: A unit of SCS is capable of handling multiple communication functions: however, different types of communication functions cannot be simultaneously performed on a serial communication module. It means that two ports must have identical communication functions.

■ OPERATING ENVIRONMENT

● Hardware Requirements

The serial communication module runs on the following SCS.

SSC60S, SSC60D, SSC50S, SSC50D, SSC57S, SSC57D, SSC10S, SSC10D

● Software Requirements

The serial communication module runs on the control functions on the following SCS.

CFS1300 Safety Control Functions Package (for SSC60□ and Vnet/IP): for SSC60□

CFS1100 Safety Control Functions Package: for SSC50□/SSC10□

CFS1170 Safety Control Functions Package: (for SSC57□ and Vnet/IP-Upstream): for SSC57□

● Engineering Requirements

Engineering work can be performed with CHS5100 Safety System Generation and Maintenance Function Package.

■ INSTALLATION ENVIRONMENT

CFS1300 Safety Control Functions Package (for SSC60□ and Vnet/IP)

No. of communication modules to be mounted (*1)	Max. 2 units/SCS (*2) (for Modbus slave communication function)
	Max. 4 units/SCS (*3) (for subsystem communication function)

- *1: Since Modbus slave communication function and Subsystem communication function modules can be mounted on the same SCS, the maximum number of communication modules is 6 units/SCS.
- *2: This is the sum of ALR111, ALR121, and ALE111.
- *3: This is the sum of ALR111 and ALR121.

CFS1100 Safety Control Functions Package

No. of communication modules to be mounted (*1)	Max. 2 units/SCS (*2) (for Modbus slave communication function)
	Max. 4 units/SCS (*3) (for subsystem communication function)

- *1: Since Modbus slave communication function and Subsystem communication function modules can be mounted on the same SCS, the maximum number of communication modules is 6 units/SCS.
- *2: This is the sum of ALR111, ALR121, and ALE111.
- *3: This is the sum of ALR111 and ALR121.

CFS1170 Safety Control Function Package (for SSC57□ and Vnet/IP-Upstream)

No. of communication modules to be mounted (*1)	Max. 2 units/SCS (*2) (for Modbus slave communication function)
	Max. 4 units/SCS (*3) (for subsystem communication function)

- *1: Modbus slave communication function and Subsystem communication function modules can be mounted on the same SCS, and the maximum number of communication modules is 6 units/SCS.
- *2: This is the sum of ALR111, ALR121, and ALE111.
- *3: This is the sum of ALR111 and ALR121.

■ MODBUS SLAVE COMMUNICATION FUNCTION

Modbus slave communication function enables ProSafe-RS a Modbus communication where an SCS acts as a Modbus slave and communicates with a Modbus master which is a different system from ProSafe-RS.

● Relationship between SCS and Modbus Master

Communication module's definition information, Modbus device addresses, mapping definition of SCS data, and so on are to be downloaded using engineering function of a Safety Engineering Station (SENG).

When a data is sent from an external Modbus master (external device), the SCS's CPU receives it through its serial communication module. The SCS's CPU sends a response message using the Modbus slave communication function to the Modbus master in response to the data request. The SCS Maintenance Support Tool displays error information and notifies the error status using the SCS status display function when an error in the serial communication module and communication content occurs.

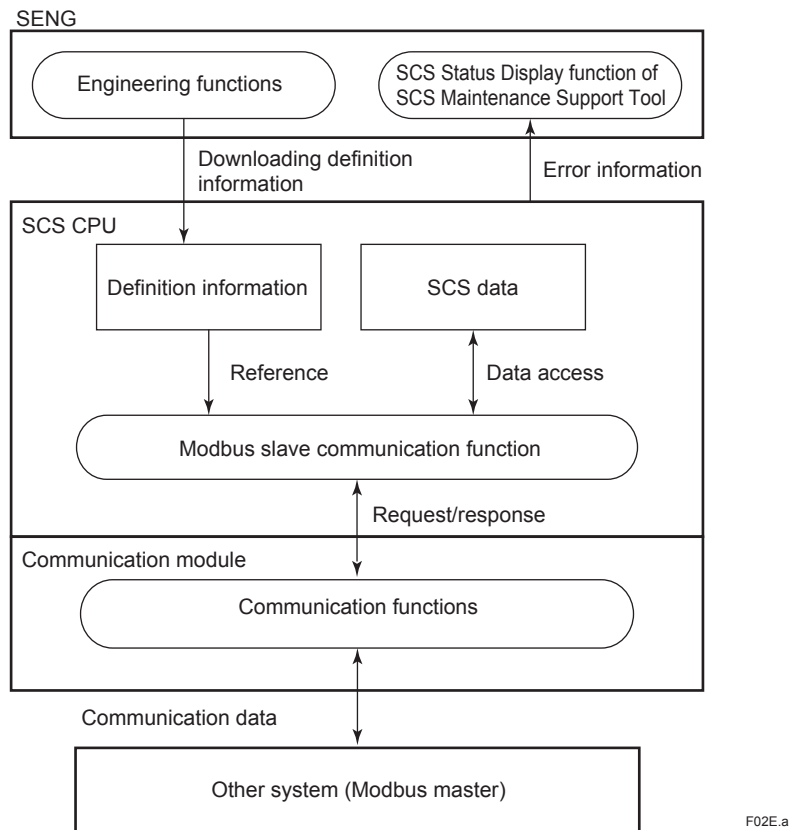

Figure Flow of data in other system

● Specification of Communication Function

- Connecting method: Connect a communication port of ALR111 or ALR121 with a serial transmission interface module
- Transmission protocol: Modbus protocol (RTU mode)

Table List of Applicable Devices

Device type	Device name	Communication capacity (per communication)	Read	Write
Bit device	Coil	32 words	Y	Y
	Input relay		Y	N
Word device	Input register	124 words	Y	N
	Maintenance register		Y	Y

Y: Applicable N: Not applicable

● **Dual-redundant Communication**

The dual-redundant configuration of the network can be available by establishing an independent transmission path from the Modbus master for every two the serial communication modules mounted in the SCS. However, control/stand-by switching function in between the dual-redundant serial communication modules mounted on adjacent slots is not supported.

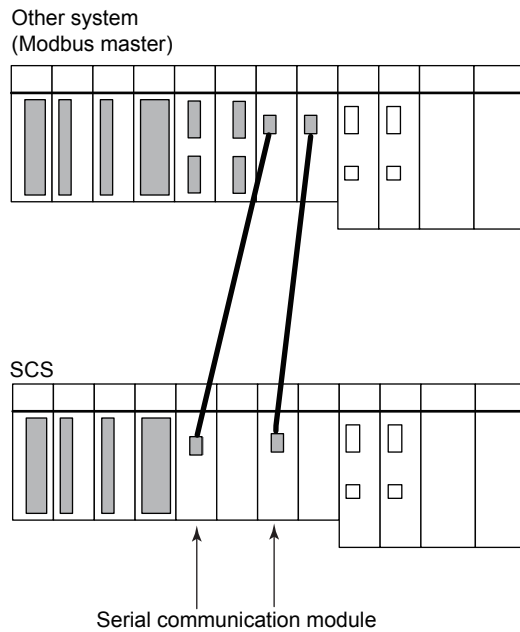

F03E.ai

Figure: Dual-redundant configuration of the serial communication modules (for dual-redundant network configuration)

■ **SUBSYSTEM COMMUNICATION FUNCTION**

Modbus communication is adopted as the subsystem communication function for ProSafe-RS that allows an SCS to act as a Modbus master to communicate with the subsystem as a Modbus slave.

ALR121 supports ProSafe-SLS communication function which is to extend the Modbus communication function. (*1) (*2)

- *1: ProSafe-SLS communication function is applicable for the single configuration only. It is not applicable for the dual-redundant configuration.
- *2: ProSafe-RS R3.02.20 or later is applicable for SSC60□, SSC50□, and SSC57□.

● Relationship between SCS and a Subsystem

The serial communication module communicates with subsystems at the specified intervals and stores the subsystem data in the communication modules' I/O image. The subsystem communication function of SCS accesses the communication module asynchronously from them, and refers to or sets the I/O image. The application logic of SCS reads data from the communication I/O data area when the communication input FB is executed, and writes the calculation data to the communication I/O data area when the communication output FB is executed.

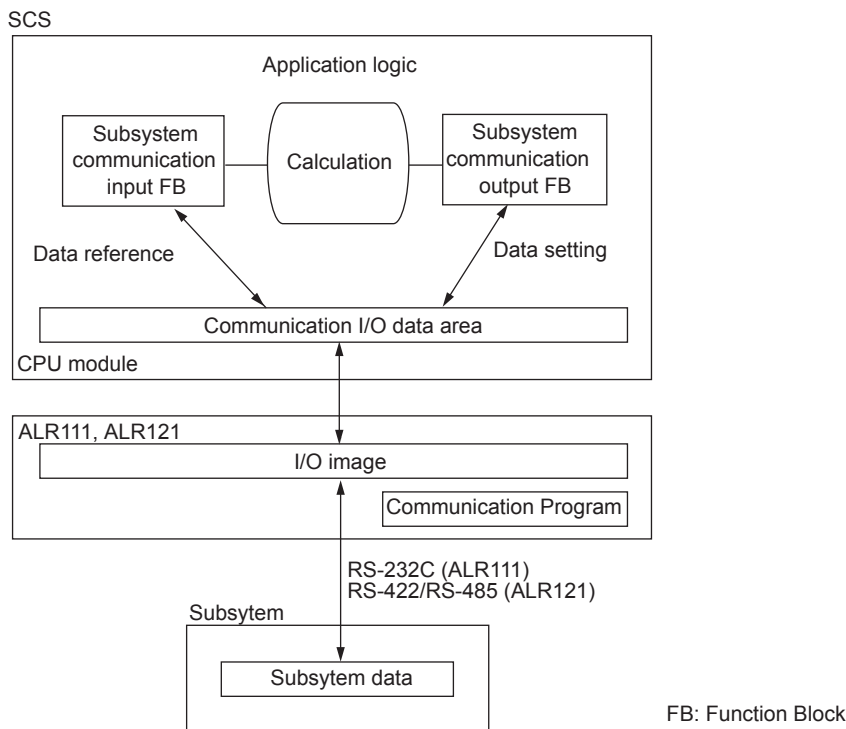

F04E.ai

Figure: Flow of Data in a subsystem

● Specification of Communication Function

- Connected device: Serial transmission interface
- Connection method: Connect a communication port of ALR111 or ALR121 with a serial transmission interface of subsystem
- Transmission protocol: Modbus protocol (RTU mode)
- No. of subsystem stations: Max. 30 stations/port
- No. of communication definition: 128 definitions/ALR111, 128 definitions/ALR121
- No. of communication data item: 500 data/SCS
- Communication I/O data capacity: Max 1000 words/SCS

Table List of Applicable Devices

Device type	Device name	Communication capacity (per communication)	Read	Write
Bit device	Coil	125 words	Y	Y
	Input relay		Y	N
Word device	Input register	125 words	Y	N
	Maintenance register		Y	Y
Other device	SLS event (*1) (*2)	24 words fixed	Y	N

Y: Applicable N: Not applicable

*1: ProSafe-SLS communication function for ALR121 only
 *2: SLS event device uses two communication definitions per allocation.

● **Dual-redundant Communication**

The dual-redundant configuration can be provided by setting the serial communication modules on an adjacent slot. Each of the ALR111 and ALR121 modules has two ports; however, the dual-redundant communication requires two communication modules. The two sets of dual-redundant communication are enabled by two ports of ALR111/ALR121; however, the communication control is defined by each communication module. When one of the communication ports detects an error, both ports switch over the control/stand-by sides to the redundant module.

Each of the two ALR111/ALR121 modules communicates with the subsystem and reads the subsystem input image data into the module. An SCS accesses the control communication module to read and use these data; however, it does not access the stand-by communication module. When the SCS detects a control communication module error or subsystem communication failure, the SCS switches its control to the stand-by module from which to read data.

A control communication module outputs data to a subsystem. The control communication module writes data to the subsystem at the specified intervals when an SCS sets the data in it. Meanwhile, the stand-by communication module re-reads and retains the output image data when it accesses the subsystem at the specified interval. This equalizes the data between the control and stand-by communication modules. When an error is detected, the SCS switches its control to the stand-by module through which the SCS continues to output data to the subsystem.

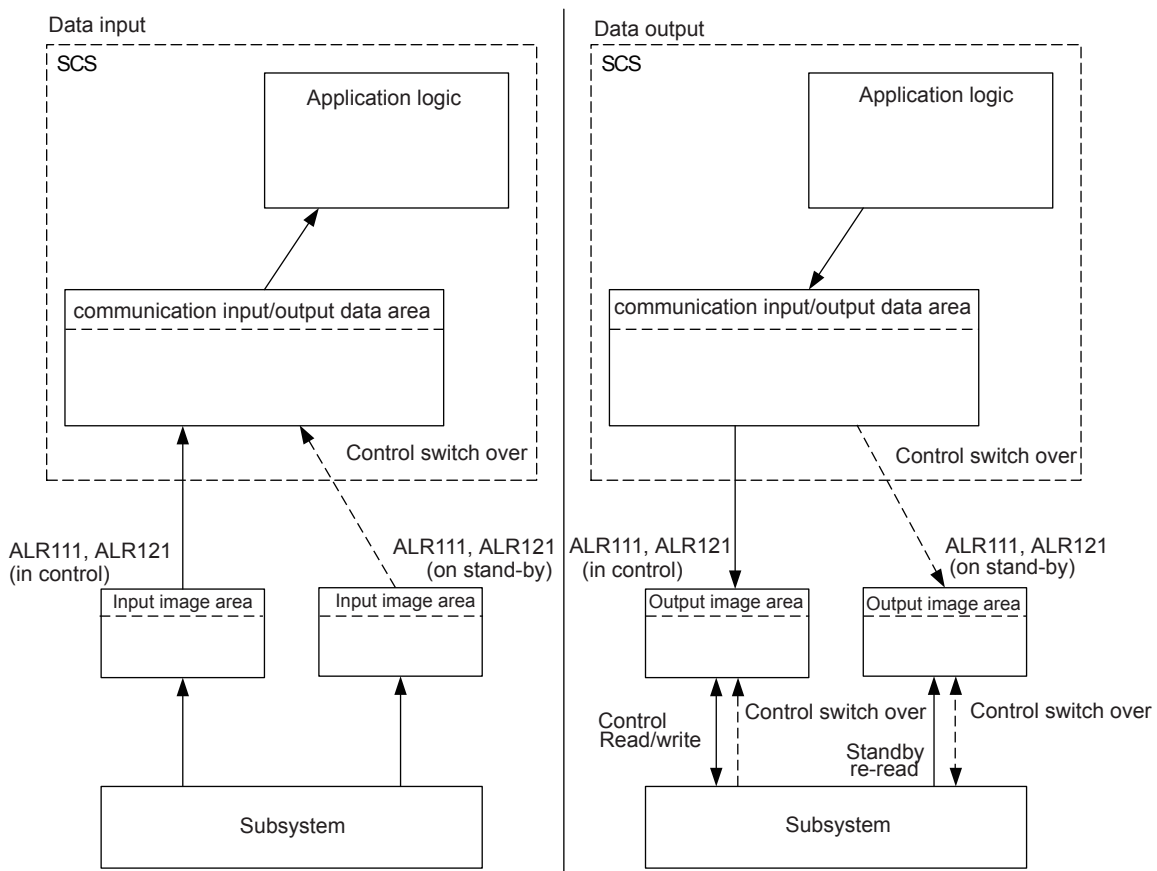

F05E.a

Figure Data Flow in Dual-redundant Configuration

● **ProSafe-SLS Communication (for ALR121 only)**

ProSafe-SLS is a safety instrumented system specifically designed for applications which require the highest Safety Integrity Levels (SIL4).

ALR121 acquires ProSafe-SLS events and data by the ProSafe-SLS communication function, which enables SCS to use those events and data in the same way as general analog and digital I/O signals.

ProSafe-SLS's system time has to be synchronized with ProSafe-RS by digital input and output modules to match the event time stamp. A bleeder resistor has to be connected on the ProSafe-SLS side to match the I/O specification of ProSafe-SLS and ProSafe-RS. (Recommended bleeder resistor: 680 ohm with 5 W or 2 W (*1))

The following figure shows a system configuration of ProSafe-RS and ProSafe-SLS. Subsystems should not be connected with ALR121 except for ProSafe-SLS where the ProSafe-SLS communication function is set.

*1: In case of using the 2 W resistor, the pulse width of DO for time synchronization has to be 1 second or less.

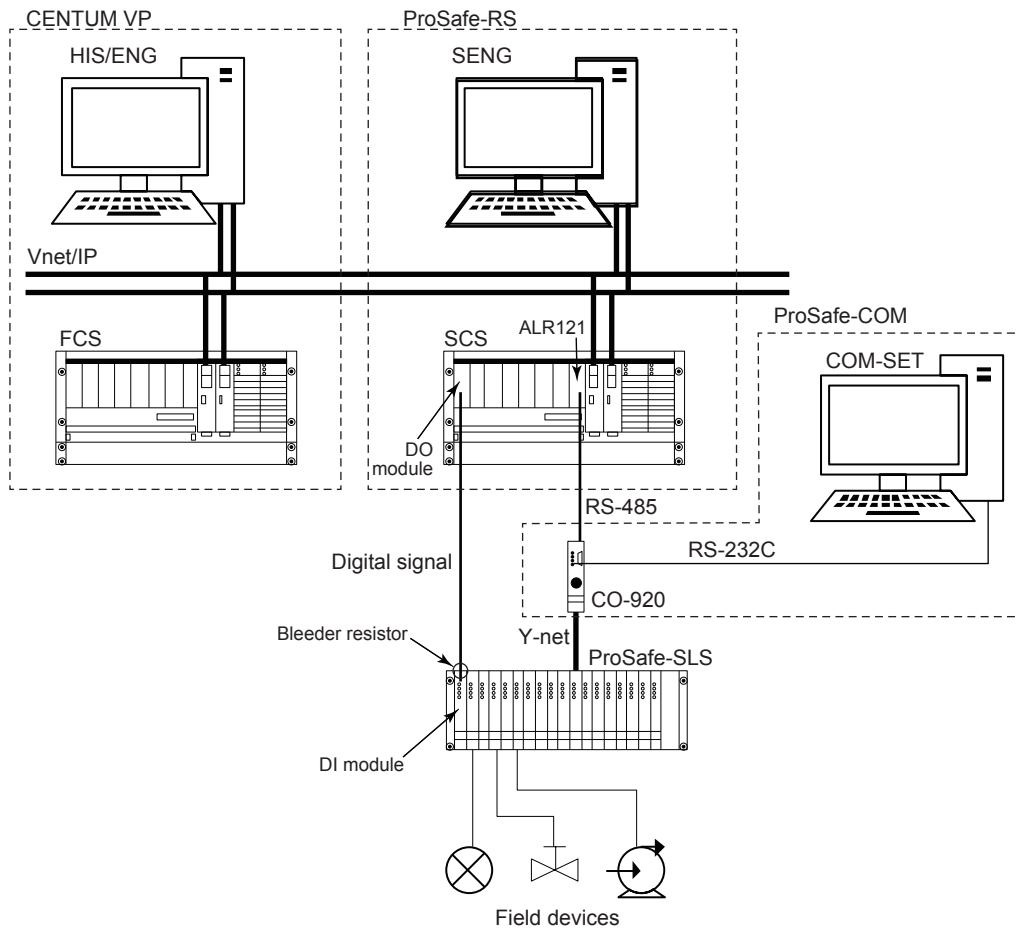

F08E.ai

Figure Example of a system configuration of ProSafe-RS and ProSafe-SLS

Table Hardware environment

System	Model name	Description	Purpose
ProSafe-RS	ALR121	Serial communication module	for Modbus communication
	SDV531 or SDV541	Digital output module	for time synchronization
ProSafe-SLS	CO-920	ProSafe-COM single card communication system controller (Firmware version 1.0 or later)	for Modbus communication
	DI-511	Digital input module (fail-safe)	for time synchronization

ProSafe-SLS's event data can be accessed from a human interface station (HIS) where ProSafe-RS is integrated with CENTUM VP/CS 3000 system. In order to notify an operator of ProSafe-SLS's failures as alarms, an application has to be configured on a SCS for judging the ProSafe-SLS data and diagnostic information.

Applicable software versions for ProSafe-RS and CENTUM are shown as below.

Table Software version/revision for ProSafe-RS and CENTUM

System	Description
ProSafe-RS	R3.02.20 or later
CENTUM CS 3000	R3.07 or later
CENTUM VP	R4.01 or later

EXTERNAL DIMENSIONS

● ALR111 Serial Communication Module (RS-232C)

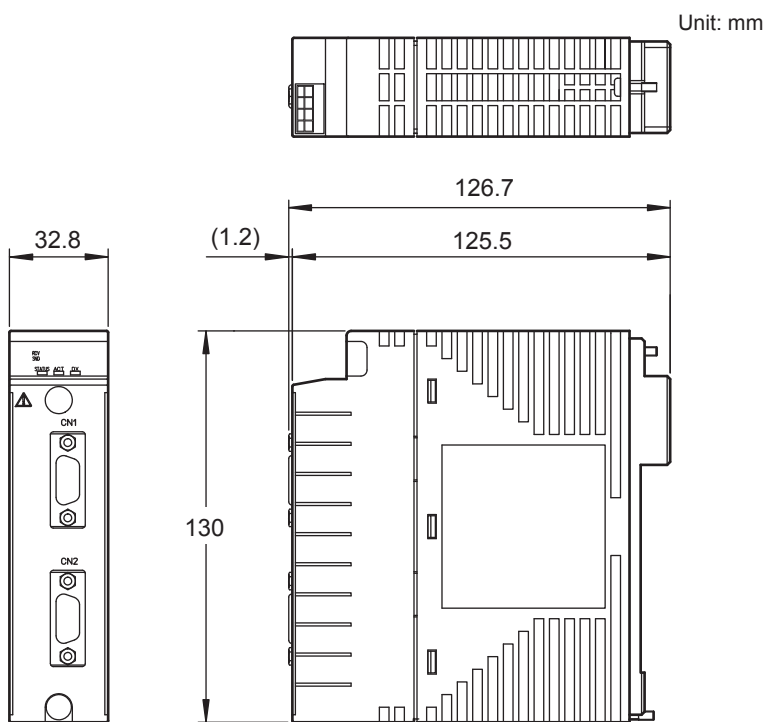

F06E.ai

Nominal Tolerances:

When the reference dimension is over 0.5 mm and equal or less than 120 mm, its nominal tolerance is ± 0.8 mm, while its combination of nominal tolerance is ± 1.5 mm.

When the reference dimension is over 120 mm, its nominal tolerance is in accordance with JEM 1459.

● **ALR121 Serial Communication Module (RS-422/RS485)**

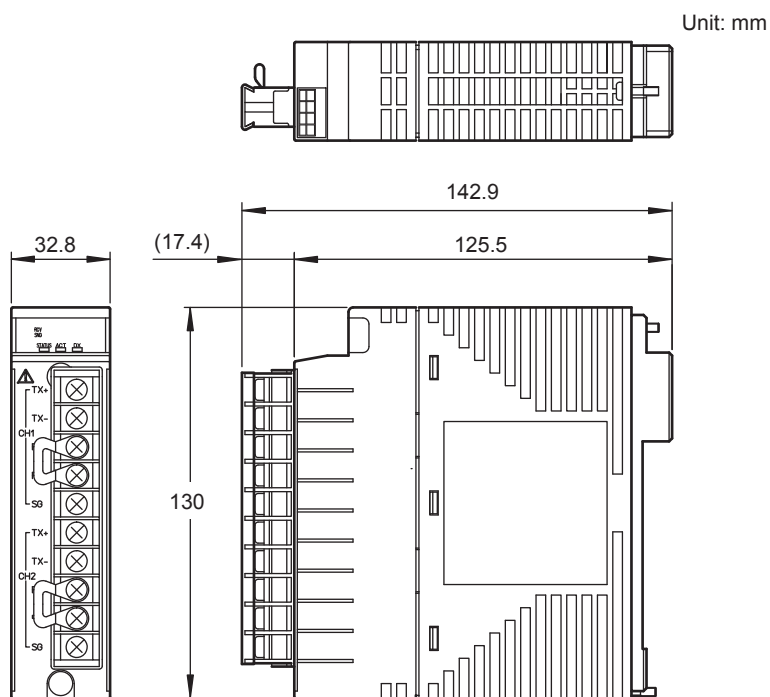

F07E.ai

Nominal Tolerances:

When the reference dimension is over 0.5 mm and equal or less than 120 mm, its nominal tolerance is ± 0.8 mm, while its combination of nominal tolerance is ± 1.5 mm.

When the reference dimension is over 120 mm, its nominal tolerance is in accordance with JEM 1459.

■ **MODEL AND SUFFIX CODES**

		Description
Model	ALR111	Serial Communication Module (RS-232C, 2 port)
Suffix Codes	-S	Standard type
	5	With no explosion protection
	E	With explosion protection
	1	With ISA Standard G3

		Description
Model	ALR121	Serial Communication Module (RS-422/RS-485, 2 port)
Suffix Codes	-S	Standard type
	5	With no explosion protection
	E	With explosion protection
	1	With ISA Standard G3
	3	With ISA Standard G3 and temperature

■ **CONFORMITY STANDARDS**

Refer to “ProSafe-RS Standards Compliant Models” (GS 32P01B60-01EN).

■ **ORDERING INFORMATION**

Specify the model and suffix codes.

For selecting the right products for explosion protection, please refer to TI 32S01J30-01E without fail.

■ **TRADEMARKS**

- CENTUM and ProSafe are registered trademarks of Yokogawa Electric Corporation.
- Other product and company names appearing in this document are trademarks or registered trademarks of their respective holders.